

Profilübersicht Eisenring

Bitte sprechen Sie mit uns die optimale Dimension eines Profils ab, da die Rohmaterialdimension je nach Holzart abweichen kann.

Profile für Fassaden (horizontale Montage)

Stülpchalung

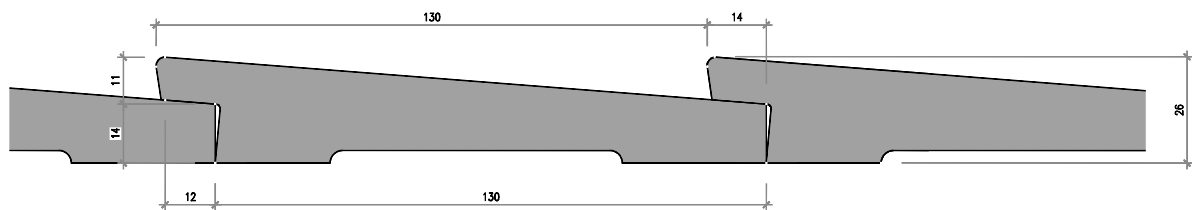

Nr. 7601-00-03 Stülpchalung Falz 14/26/130 mm, Rückseitig ausgekehlt

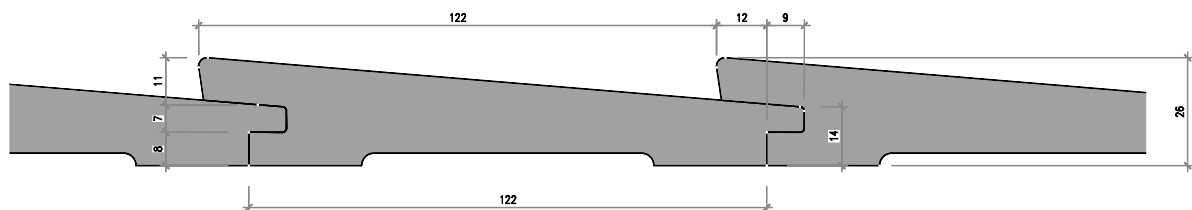

Nr. 7702-00-03 Stülpchalung N+K 14/26/122 mm, Rückseitig ausgekehlt

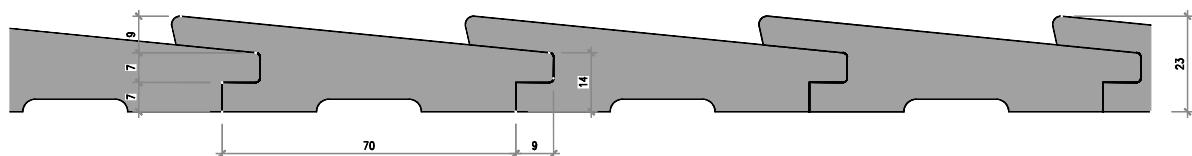

Nr. 7702-00-03 Stülpchalung N+K 14/23/70 mm, Rückseitig ausgekehlt

Rhomboid 20°

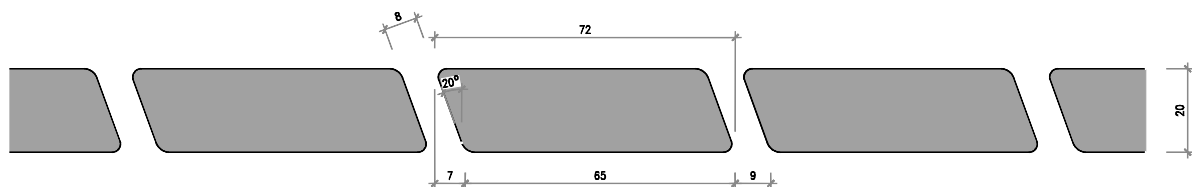

Nr. 6501-4k-03 Rhomboidschalung 20° 20/72 mm

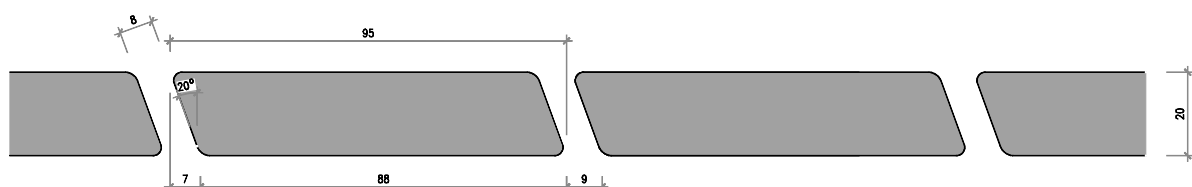

Nr. 6501-4k-03 Rhomboidschalung 20° 20/95 mm

Rhomboid N+K

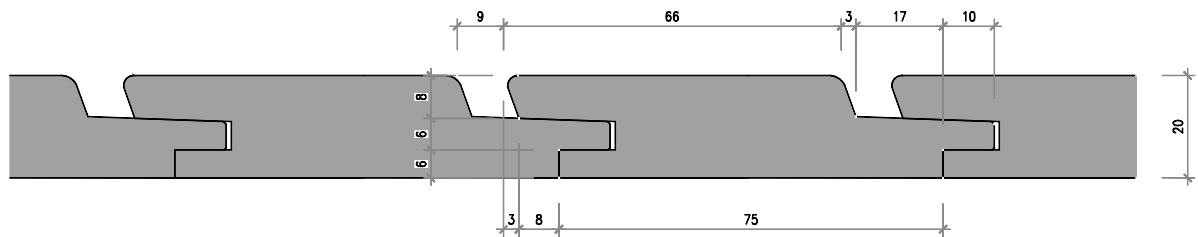

Nr. 6602-09-03

Rhomboidschalung N+K 20/75 mm

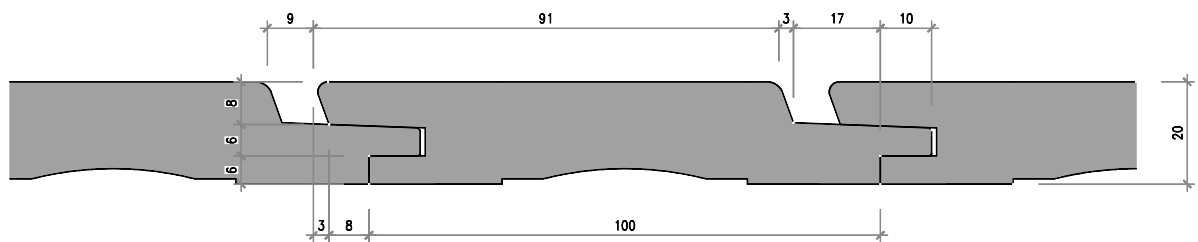

Nr. 6602-09-03

Rhomboidschalung N+K 20/100 mm

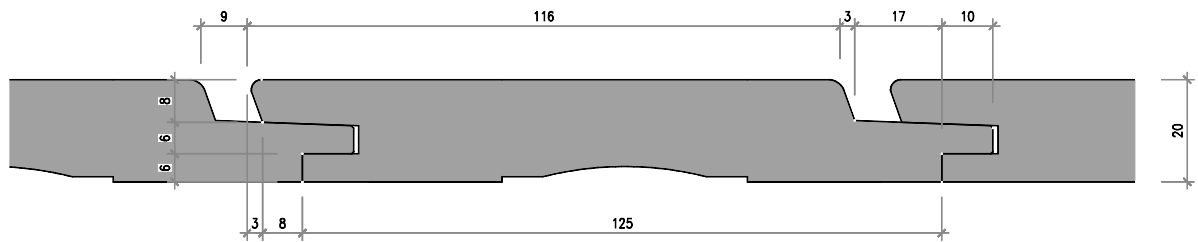

Nr. 6602-09-03

Rhomboidschalung N+K 20/125 mm

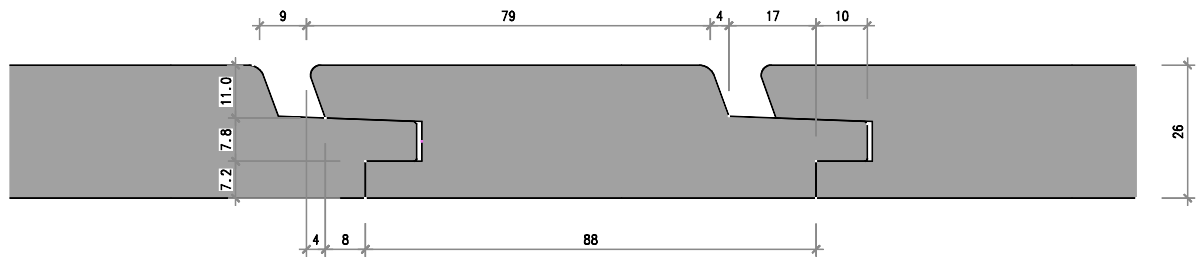

Nr. 6602-09-03

Rhomboidschalung N+K 26/88 mm

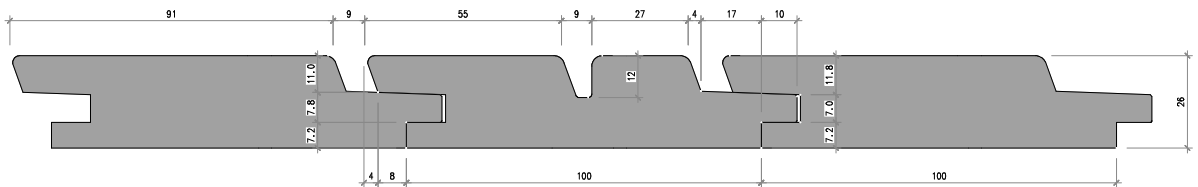

Nr. 6672-09-03

Rhomboid N+K Trio mit verschobener Mittelnut, Radius 3 mm, 3 Teile

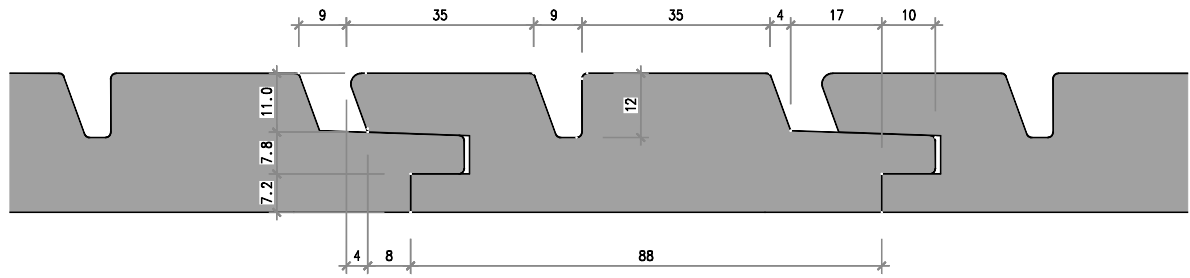

Nr. 6622-09-03 Rhomboid N+K 26/88 mm, mit Mittelnut

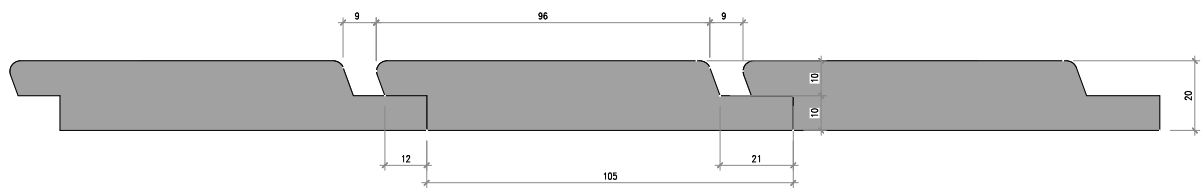

Nr. 6001-09-03 Wechselfalz mit Rhomboid 20°

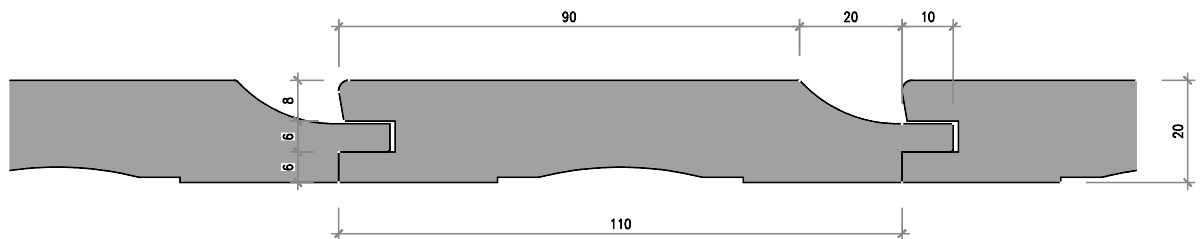

Nr. 7101-20-03 Chaletschalung 20/110 mm, ausgekehlt, Kante gerundet

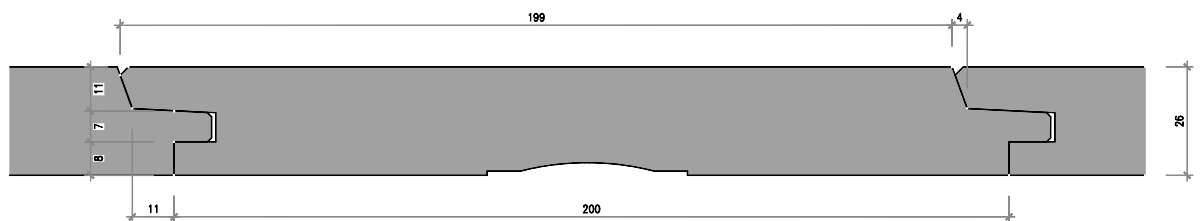

Nr. 6604-00-02 Strickwandimitation N+K 26/200 mm (Für nicht bewitterte Flächen)

Profile für Fassaden (vertikale Montage)

Sichtnut gerade

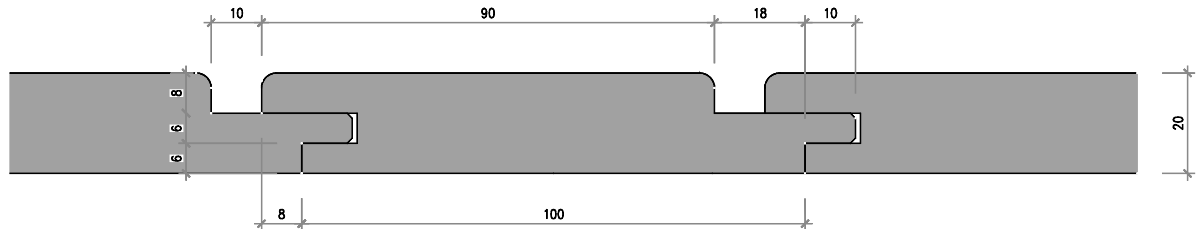

Nr. 2202-10-03 Sichtnutschalung gerade 20/100 mm, Nut 10 mm, Radius 3 mm

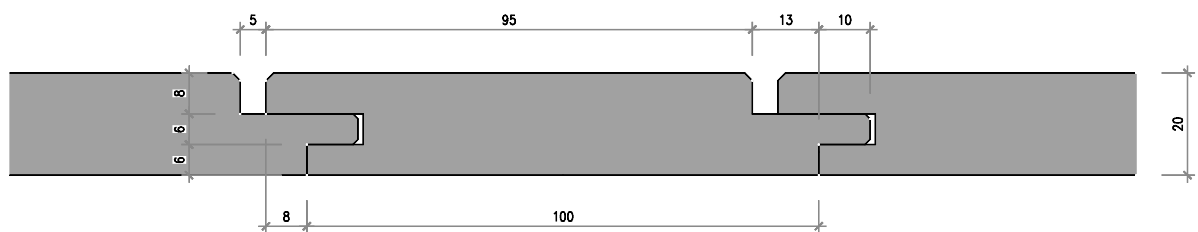

Nr. 2204-05-02 Sichtnutschalung gerade 20/100 mm, Fase 2 mm

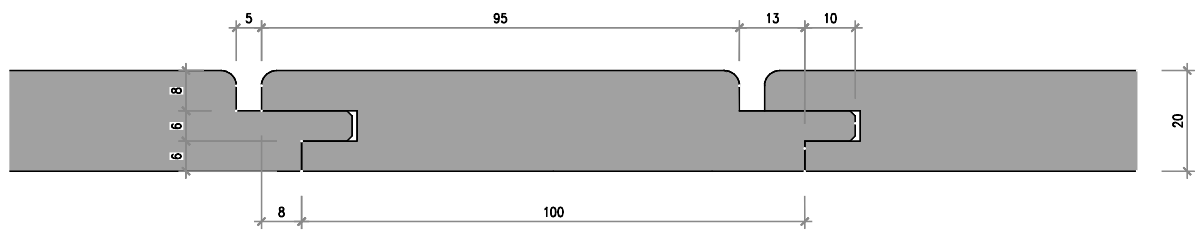

Nr. 2202-05-03 Sichtnutschalung gerade 20/100 mm, Nut 5 mm, Radius 3 mm

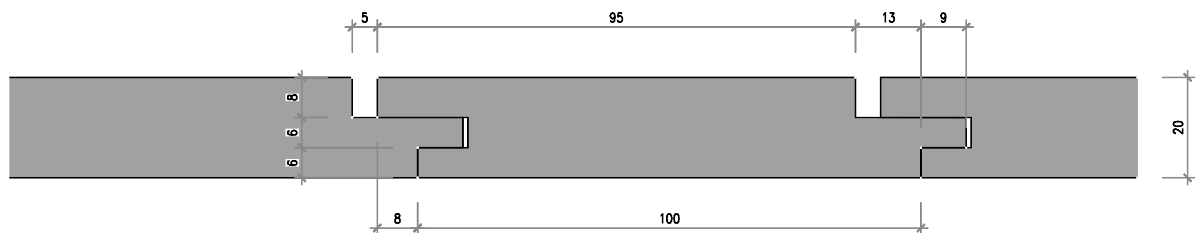

Nr. 2206-05-00 Sichtnutschalung gerade 20/100 mm, scharfkantig

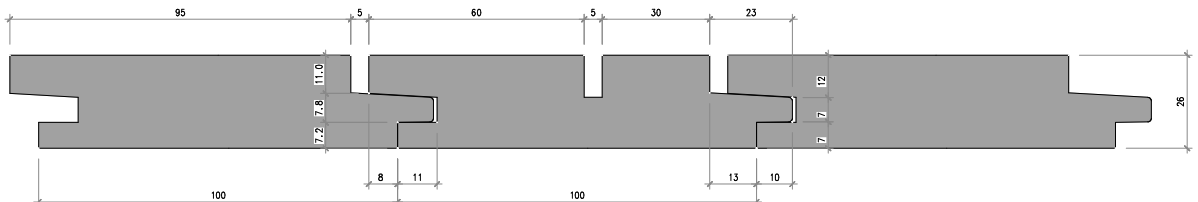

Nr. 2276-05-00 Sichtnut Trio gerade mit verschobener Mittelnut, 3 Teile

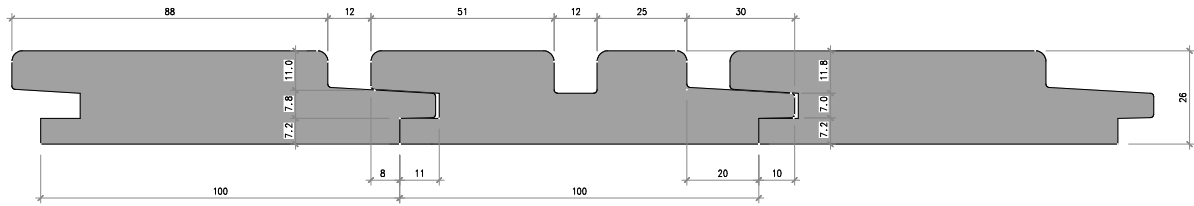

Nr. 2272-12-03 Sichtnut Trio gerade mit verschobener Mittelnut, 3 Teile

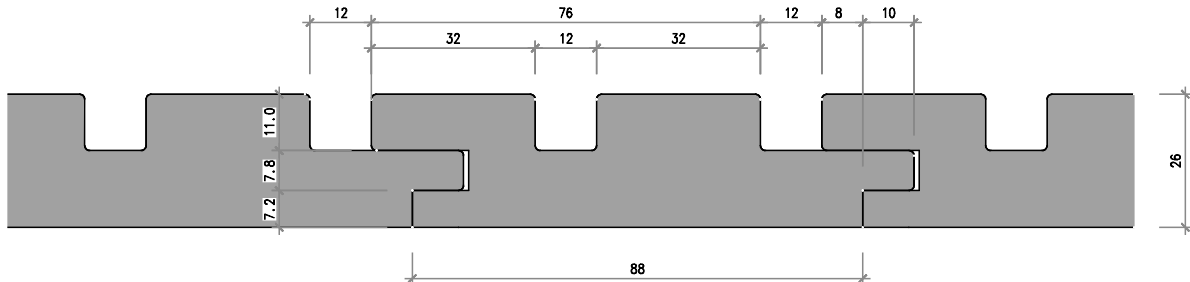

Nr. 2222-12-03 Sichtnutschalung gerade 26/88 mm mit Mittelnut, Kamm 10mm Für verdeckte Montage

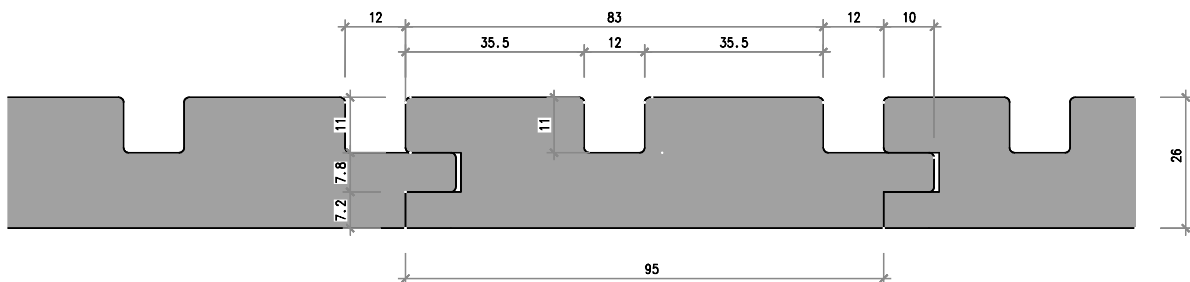

Nr. 2221-12-03 Sichtnutschalung gerade 26/95 mm mit Mittelnut, Kamm 10 mm

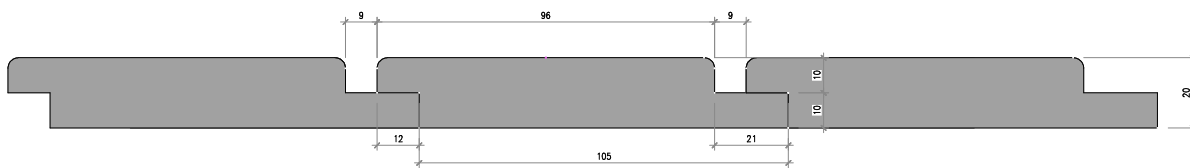

Nr. 8001-09-03 Wechselfalz mit Sichtnut gerade

Sichtnut 15°

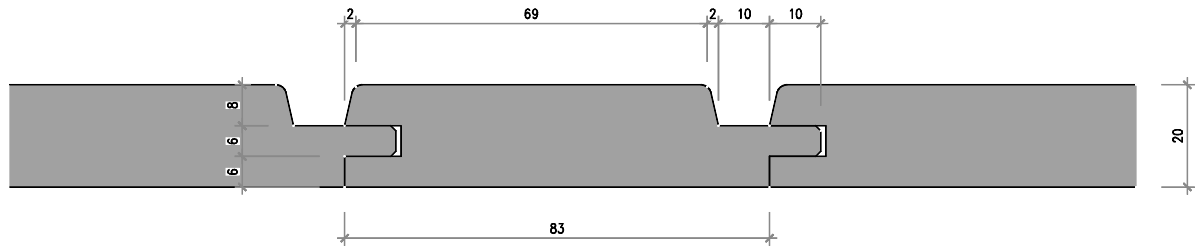

Nr. 2101-10-03

Sichtnut 20/83 mm, Nut 10 mm, Radius 3 mm

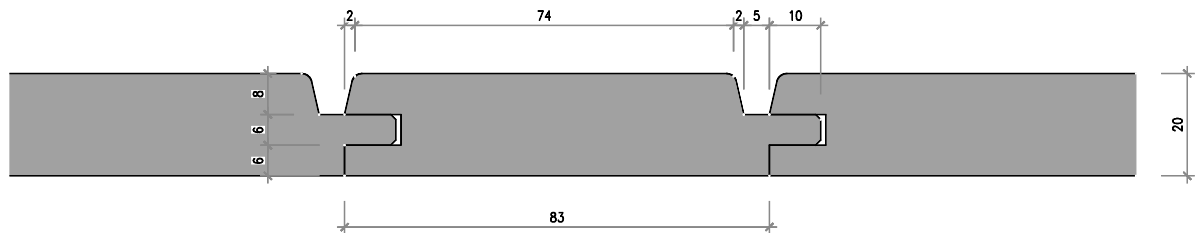

Nr. 2101-05-03

Sichtnut 20/83 mm, Nut 5 mm, Radius 3 mm

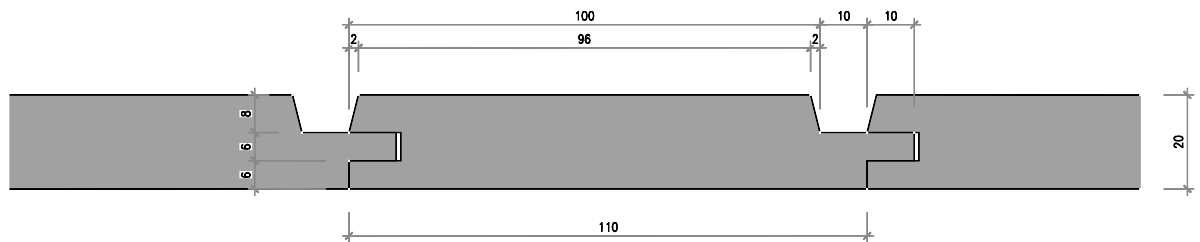

Nr. 2105-10-00

Sichtnuttäfer 20/110 mm, Nut 10 mm

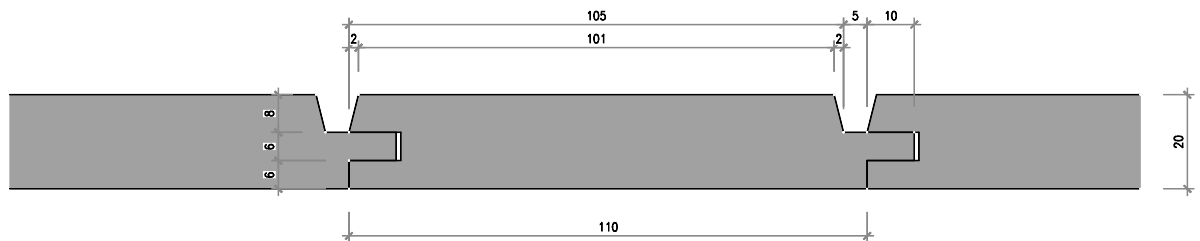

Nr. 2105-05-00

Sichtnuttäfer 20/110 mm, Nut 5 mm

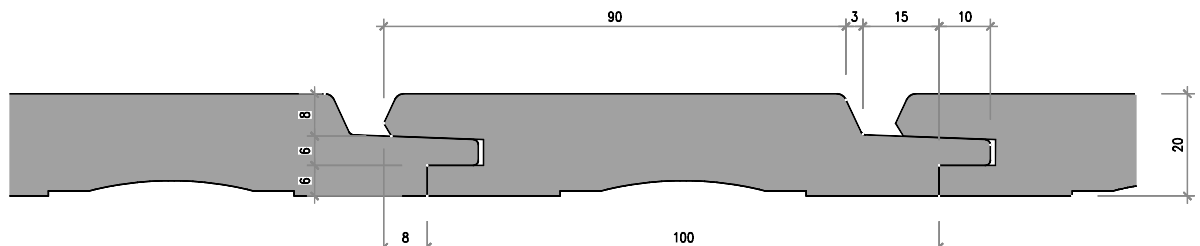

Nr. 2112-06-03

Sichtnut 20/100 mm, Radius 3 mm (Für verdeckte Montage)

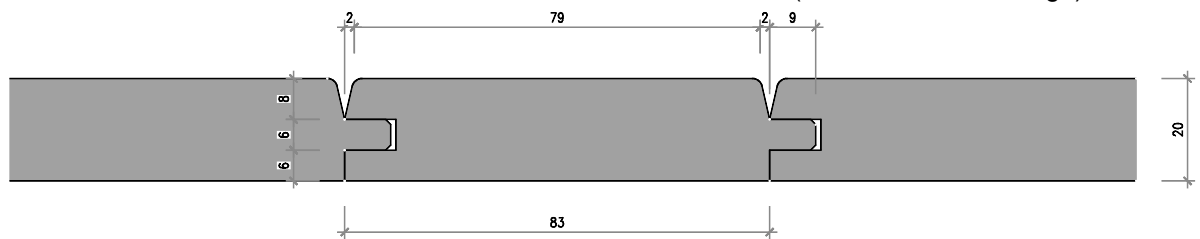

Nr. 1201-04-03

Steilfas 20/83 mm, Radius 3 mm

Schirmbretter

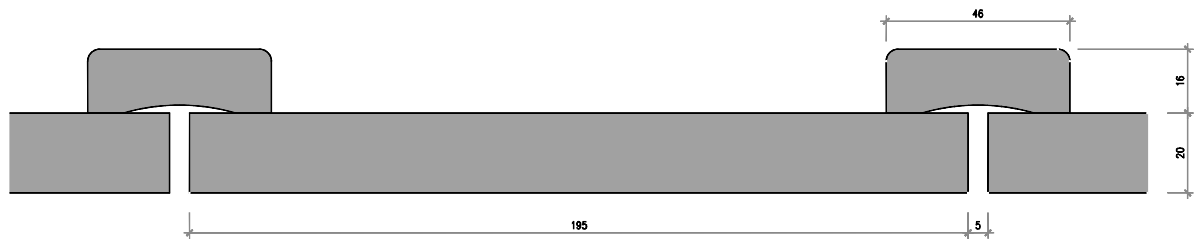

Nr. 81a01-2k-03
Nr. 8103-2k-01

Deckleiste Fichte 16/46 mm, ausgekehlt, Radius 3 mm
Schirmbretter 20/195 mm Grundbrett

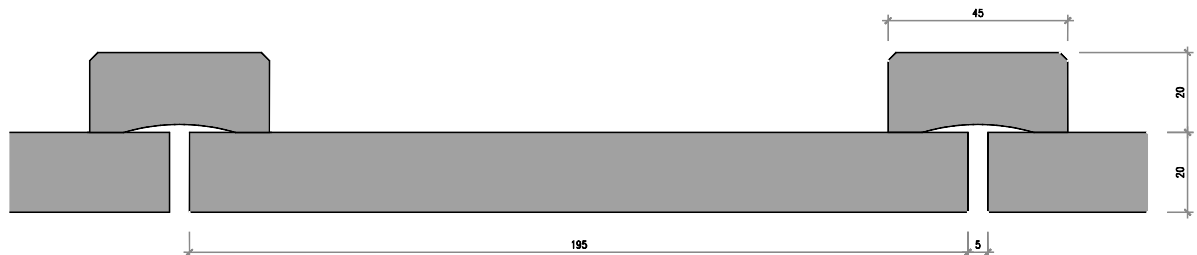

Nr. 81a03-2k-02
Nr. 8103-2k-01

Deckleiste Lärche 20/45 mm, ausgekehlt, Fase 3 mm
Schirmbretter 20/195 mm Grundbrett

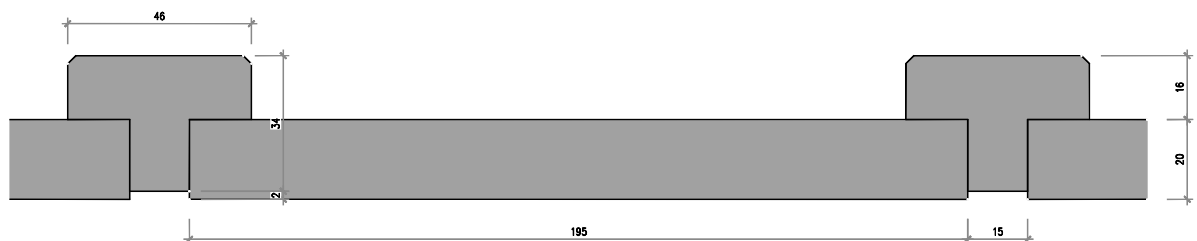

Nr. 81b03-15-02

T-Leiste 35/46 mm für Leistenschirm



Nr. 8303-2k-02
Nr. 8103-2k-01

Deckelschalung Deckbrett 3-seitig sichtbar 20/200 mm
Schirmbretter Grundbrett 20/195 mm

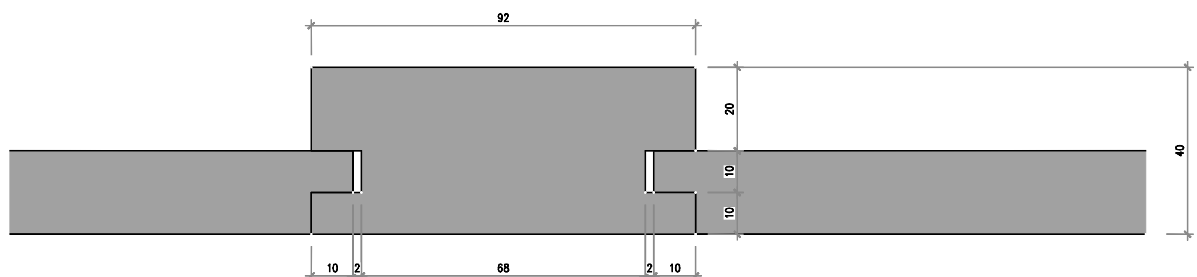

Nr. 83c05-4k-00
Nr. 83b03-2k-01

Deckbrett 3-seitig sichtbar 40/92 mm, Nut 10/12 mm
Grundbrett (wie T-Leiste), Falz 10/10 mm

Spezialprofile

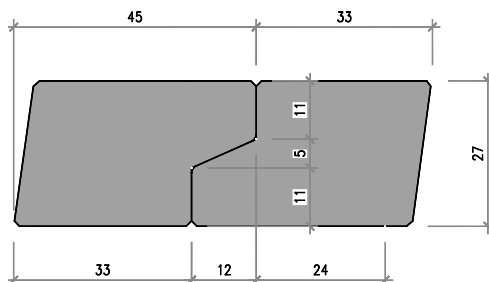

Nr. 9503-4k-01

Einhängelatten für Wand- und Fassadenelemente 27/45 mm

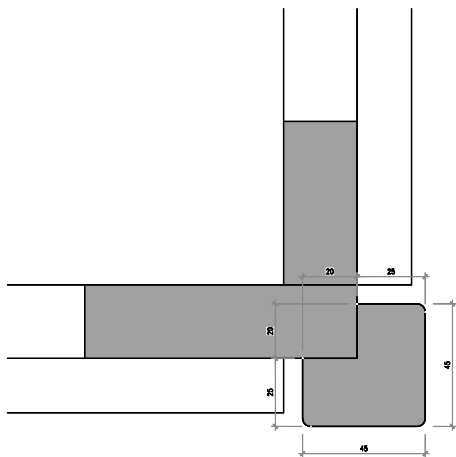

Nr. 82b01-3k-03
Fassadeneckprofil L 45/45 mm, 20/20 mm
ausgekehrt, Radius 3 mm

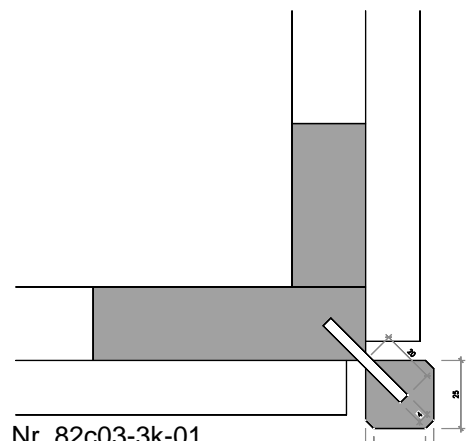

Nr. 82c03-3k-01
Fassadeneckprofil Smart 25/25 mm
mit 4/20 mm Nut, Fase 3 mm

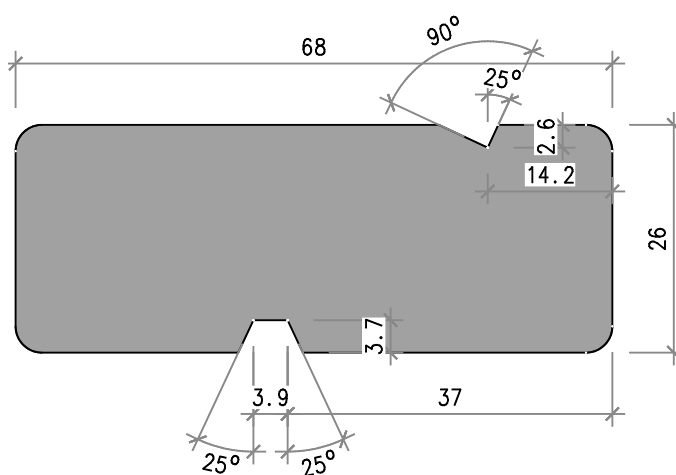

Nr. 6101-CA-03

Cadex Sichtschutz 26/88 mm